

PRELIMINARY SPEC



ATTENTION
OBSERVE PRECAUTIONS
FOR HANDLING
ELECTROSTATIC
DISCHARGE
SENSITIVE
DEVICES

Part Number: APTF1616SEEVGAPBAC

Hyper Orange
Green
Blue

Features

- 1.6mmX1.6mm SMT LED, 0.7mm THICKNESS
- LOW POWER CONSUMPTION
- ONE BLUE, ONE RED AND ONE GREEN CHIPS IN ONE PACKAGE
- CAN PRODUCE ANY COLOR IN VISIBLE SPECTRUM, INCLUDING WHITE LIGHT
- PACKAGE : 2000PCS / REEL.
- MOISTURE SENSITIVITY LEVEL : LEVEL 3.
- RoHS COMPLIANT.

Description

The Hyper Orange source color devices are made with InGaAlP on GaAs substrate Light Emitting Diode.

The Green source color devices are made with InGaN on G-SiC Light Emitting Diode.

The Blue source color devices are made with InGaN on SiC Light Emitting Diode.

Static electricity and surge damage the LEDs.

It is recommended to use a wrist band or anti-electrostatic glove when handling the LEDs.

All devices, equipment and machinery must be electrically grounded.

Package Dimensions

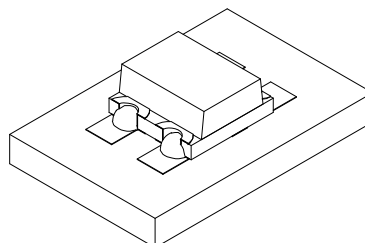
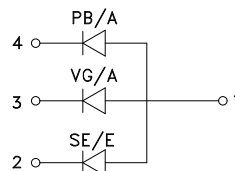
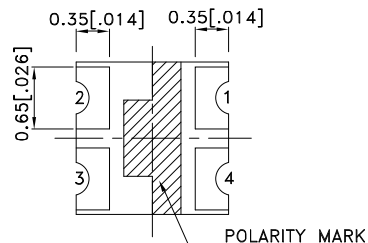
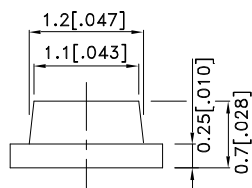
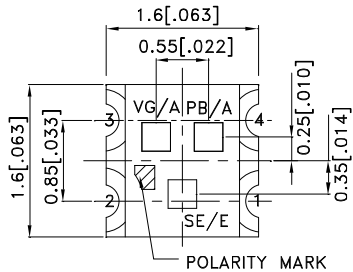

Notes:

1. All dimensions are in millimeters (inches).
2. Tolerance is ± 0.2 (0.008") unless otherwise noted.
3. Specifications are subjected to change without notice.
4. The device has a single mounting surface. The device must be mounted according to the specifications.



Selection Guide

Part No.	Dice	Lens Type	Iv (mcd) [2] @ 20mA		Viewing Angle [1]
			Min.	Typ.	2θ1/2
APTF1616SEEVGAPBAC	Hyper Orange (InGaAlP)	WATER CLEAR	180	400	120°
	Green (InGaN)		70	180	
	Blue (InGaN)		10	40	

Notes:

1. θ1/2 is the angle from optical centerline where the luminous intensity is 1/2 the optical centerline value.
2. Luminous intensity/ luminous Flux: +/-15%.

Electrical / Optical Characteristics at TA=25°C

Symbol	Parameter	Device	Typ.	Max.	Units	Test Conditions
λ _{peak}	Peak Wavelength	Hyper Orange Green Blue	630 520 468		nm	I _F =20mA
λ _D [1]	Dominant Wavelength	Hyper Orange Green Blue	621 525 470		nm	I _F =20mA
Δλ _{1/2}	Spectral Line Half-width	Hyper Orange Green Blue	20 35 21		nm	I _F =20mA
C	Capacitance	Hyper Orange Green Blue	25 100 100		pF	V _F =0V;f=1MHz
V _F [2]	Forward Voltage	Hyper Orange Green Blue	2 3.2 3.2	2.5 4 4	V	I _F =20mA
I _R	Reverse Current	Hyper Orange Green Blue		10 10 10	uA	V _R =5V

Notes:

1. Wavelength: +/-1nm.
2. Forward Voltage: +/-0.1V.

Absolute Maximum Ratings at TA=25°C

Parameter	Hyper Orange	Green	Blue	Units
Power dissipation	75	120	120	mW
DC Forward Current	30	30	30	mA
Peak Forward Current [1]	195	100	100	mA
Reverse Voltage	5			V
Operating Temperature	-40°C To +85°C			
Storage Temperature	-40°C To +85°C			

Notes:

1. 1/10 Duty Cycle, 0.1ms Pulse Width.

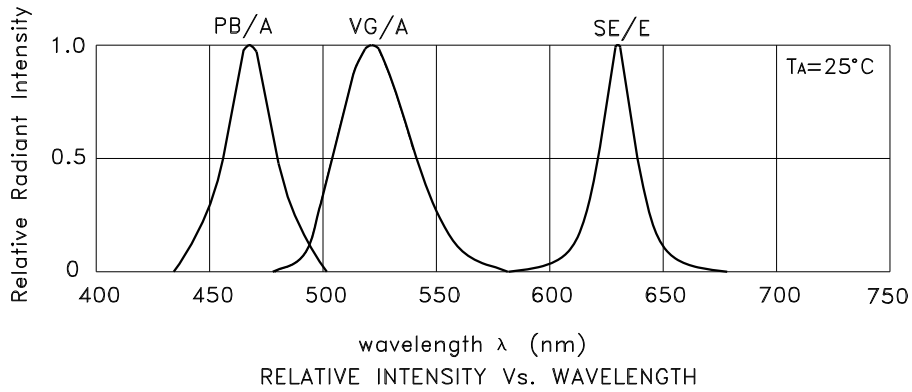

APTF1616SEEVGAPBAC
Hyper Orange

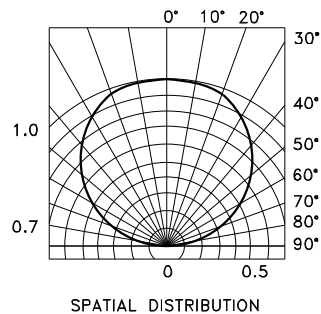
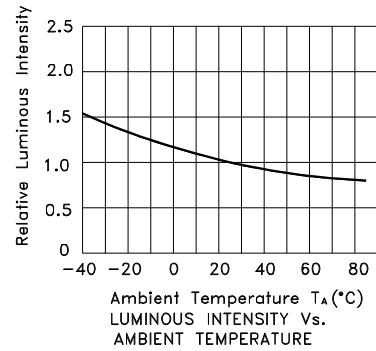
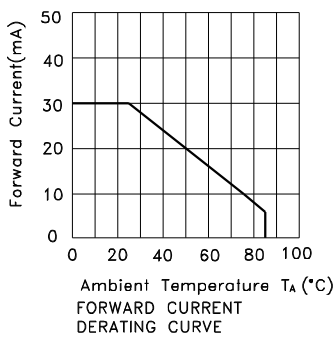
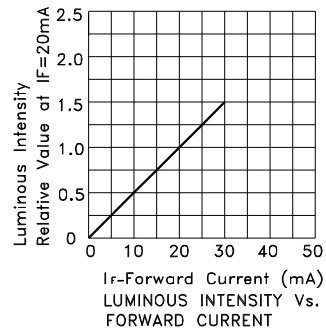
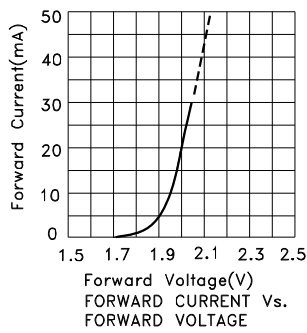

Green

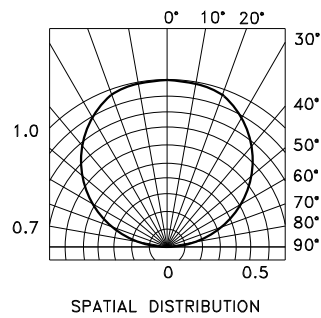
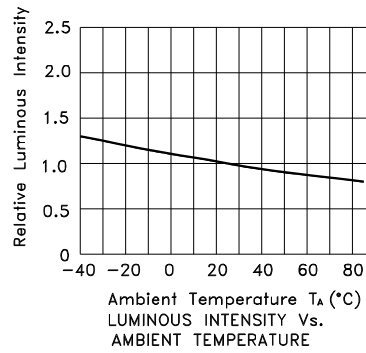
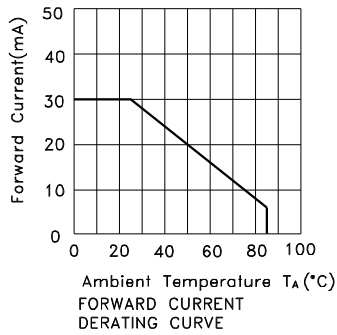
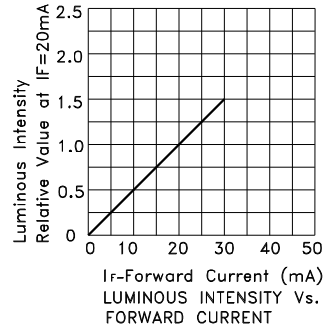
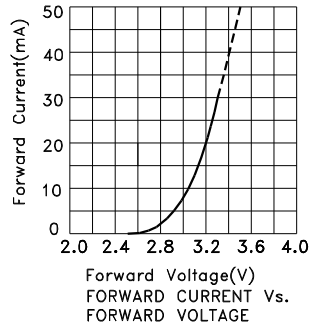

Kingbright

Blue

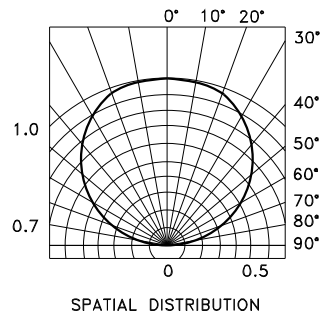
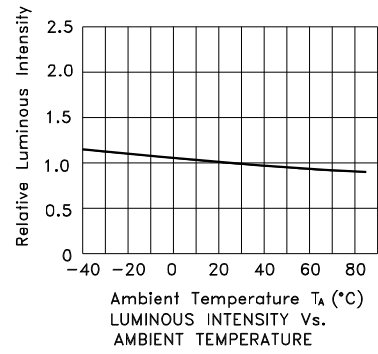
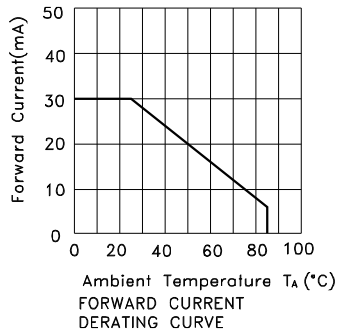
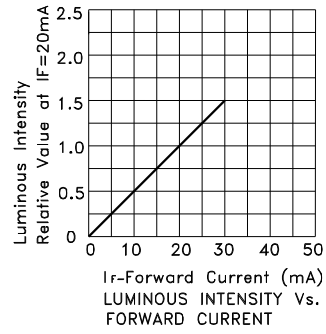
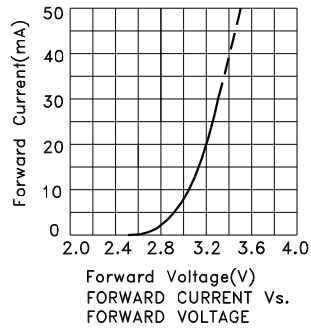

APTF1616SEEVGAPBAC

Reflow Soldering Profile For Lead-free SMT Process.

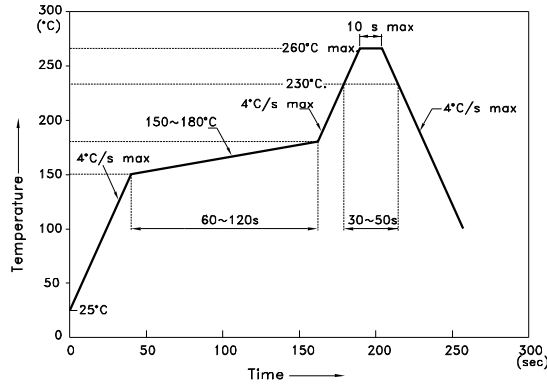

NOTES:

1. We recommend the reflow temperature 245°C(+/-5°C). The maximum soldering temperature should be limited to 260°C.
2. Don't cause stress to the epoxy resin while it is exposed to high temperature.
3. Number of reflow process shall be 2 times or less.

Recommended Soldering Pattern (Units : mm; Tolerance: ± 0.1)

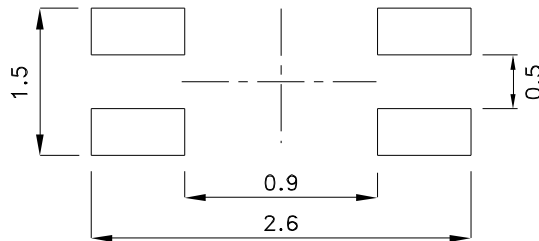

Tape Specifications (Units : mm)

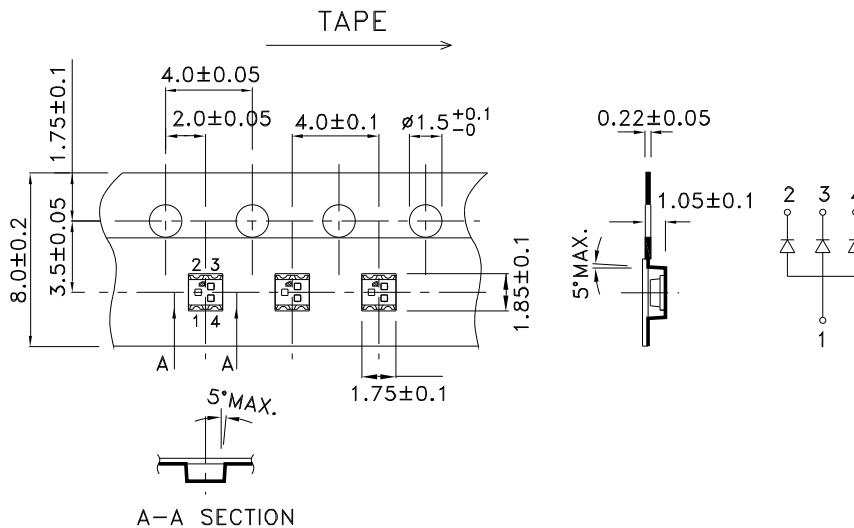

Kingbright

PACKING & LABEL SPECIFICATIONS

APTF1616SEEVGAPBAC

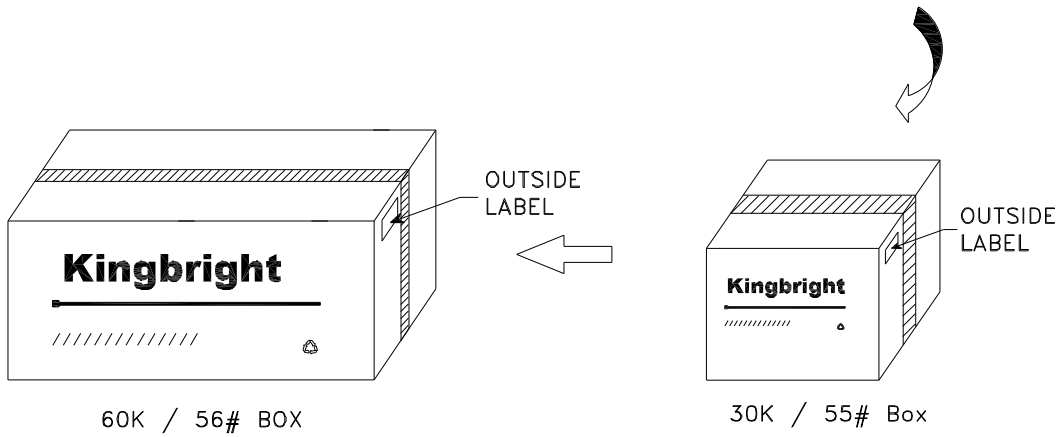
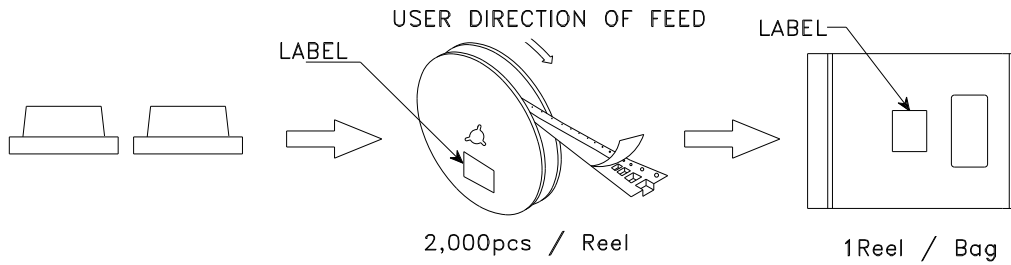

Kingbright	
Q.C.	<div style="border: 1px solid black; border-radius: 50%; padding: 5px; display: inline-block;"> QC XXX XX. XXXX PASSED </div>
TYPE NO : APTF1616xxx	
QUANTITY : 2,000 pcs	
S/N : XXX	CODE: XXXX
LOT NO :  <small>xx-xxxxxx</small>	
RoHS Compliant	